

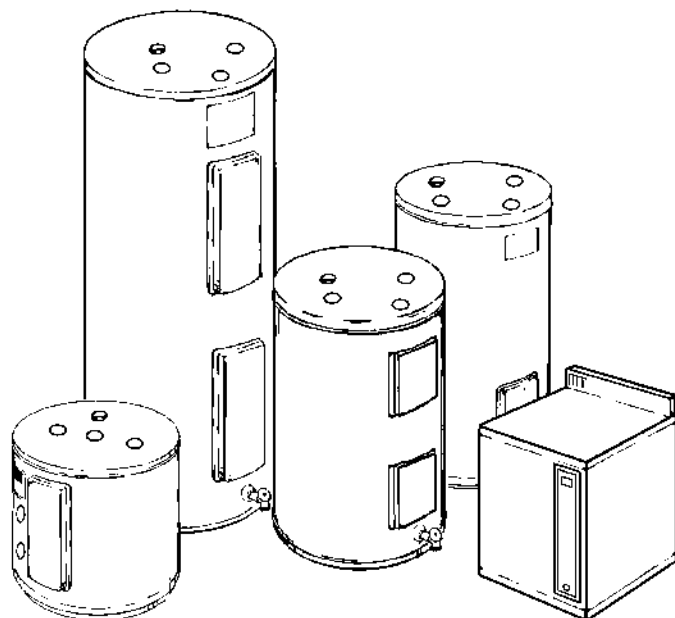
## STORAGE TANKS FOR INSTANTANEOUS WATER HEATERS

For FlowThru® Brands



**WARNING:** If the information in these instructions is not followed exactly, a fire or explosion may result causing property damage, personal injury or death.

- Do not store or use gasoline or other flammable vapours and liquids in the vicinity of this or any other appliance.
- **WHAT TO DO IF YOU SMELL GAS:**
  - Do not try to light any appliance.
  - Do not touch any electrical switch; do not use any phone in your building.
  - Immediately call your gas supplier from a neighbor's phone. Follow the gas supplier's instructions.
  - If you cannot reach your gas supplier, call the fire department.
- Installation and service must be performed by a qualified installer, service agency or the gas supplier.



	<b>⚠ WARNING</b>
	<p>Read and understand instruction manual and safety messages before installing, operating or servicing this water heater.</p> <p>Failure to follow instructions and safety messages could result in death or serious injury.</p> <p>Instruction manual must remain with water heater.</p>

• **For Your Safety** •  
AN ODOURANT IS ADDED TO THE GAS USED BY THIS WATER HEATER.

ALL TECHNICAL AND WARRANTY QUESTIONS: SHOULD BE DIRECTED TO THE LOCAL DEALER FROM WHOM THE WATER HEATER WAS PURCHASED. IF YOU ARE UNSUCCESSFUL, PLEASE CONTACT THE COMPANY LISTED ON THE RATING PLATE ON THE WATER HEATER.

KEEP THIS MANUAL IN THE POCKET ON HEATER FOR FUTURE REFERENCE  
WHENEVER MAINTENANCE ADJUSTMENT OR SERVICE IS REQUIRED.

# TABLE OF CONTENTS

INTRODUCTION .....	3
Description .....	3
SAFETY .....	3
Relief Valve Requirements .....	3
INSTALLATION .....	3
Local Codes .....	3
Location .....	3
Circulator Pump .....	4
Sizing The Hot Water System .....	4
Plumbing Connections .....	4
Electrical Wiring .....	6
Filling .....	6
OPERATION .....	6
Temperature Adjustment .....	6
Initial Temperature Adjustment .....	7
Temperature Limit Control .....	7
MAINTENANCE .....	7
Temperature and Pressure Relief Valve .....	7
Draining and Flushing .....	7
Water Odor/Sacrificial Anode .....	8
Anode Maintenance .....	8
LIMITED WARRANTY .....	9

## INTRODUCTION

Thank you for purchasing this FlowThru® storage tank. Properly installed and maintained, it will provide years of trouble free service.

The warranty on this storage tank is in effect only when the tank is installed and operated in accordance with these instructions. The manufacturer of this tank will not be liable for any injury or property damage resulting from failure to comply with these instructions.

**Important:** Read and understand these instructions before installing and operating your storage tank.

## DESCRIPTION

The FlowThru® series of storage tanks have been designed to supply hot water for domestic use when combined with a tankless coil boiler or instantaneous water heater (IWH). Each tank is equipped with an adjustable thermostat, pre-wired and ready for connection to a circulator pump (not supplied). These tanks are not constructed to ASME requirements and should not be used for such applications. The FlowThru® series of storage tanks has been optimized to maximize hot water flow rate capabilities of an instantaneous water heater or tankless coil boiler. They provide a faster recovery than regular electric or gas-fired tank type water heaters of the same storage capacity. Always use a mixing valve on the hot water outlet (not provided).

## SAFETY

### RELIEF VALVE REQUIREMENTS

For protection against excessive temperatures and pressure, install temperature and pressure protective equipment required by local codes, but no less than a combination Temperature and Pressure (T&P) Relief Valve certified as meeting the requirements for “**Standard For Relief Valves For Hot Water Supply Systems, ANSI Z21.22/CSA 4.4**”. The valve shall be marked with a maximum set pressure not to exceed the maximum working pressure of the storage tank. The T&P valve shall be rated for the BTU input of the entire system. This T&P valve may be in addition to any T&P valve that is required on the boiler or instantaneous water heater system. Install the valve into the opening provided on the storage tank, or other approved system location. Provide tubing so that any discharge from the valve will exit within 152mm (6 in.) above, or any distance below the structural floor and cannot contact any live electrical part. The end of the relief pipe opening should terminate near the floor drain or other suitable location. Do not place a valve(s) or any other blockage or restrictions between the tank and the T&P valve.

## INSTALLATION

### ⚠ WARNING

#### Excessive Weight Hazard

**Use two or more people to move and install water heater.**

**Failure to do so can result in back or other injury.**

## LOCAL CODES

The installation of this storage tank must be in accordance with these Instructions and all applicable local codes.

## LOCATION

Locate the storage tank in a clean dry area close to the water-heating source and preferably central to the piping system. Adequate clearance for accessibility to permit maintenance and service must be provided. Water lines and the storage tank should be protected from freezing temperatures. Do not install the storage tank in outdoor unprotected areas. It is necessary to have a floor drain nearby to permit easy draining (see Figure 1).

### IMPORTANT

This storage tank must be installed strictly in accordance with the instructions enclosed, and local electrical, fuel and building codes. It is possible that connections to the tank, or the tank itself, may develop leaks. IT IS THEREFORE IMPERATIVE that the storage tank be installed so that any leakage of the tank or related water piping is directed to an adequate drain in such a manner that it cannot damage the building, furniture, floor covering, adjacent areas, lower floors of the structure or other property subject to water damage. This is particularly important if the tank is installed in a multi-story building, on finished flooring or carpeted surfaces. GSW WILL NOT ASSUME ANY LIABILITY for damage caused by water leaking from the storage tank, pressure relief valve, or related fittings. Select a location as centralized within the piping system as possible. In any location selected, it is recommended that a suitable drain pan be installed under the storage tank. This pan must limit the water level to a MAXIMUM depth of 45mm (1 3/4 in.) and have a diameter that is a minimum of 50mm (2 in.) greater than the diameter of the storage tank. Suitable piping shall connect the drain pan to a properly operating floor drain.

## CIRCULATOR PUMP

A circulator pump is not supplied. Use only a bronze body model rated for 110/120 volts, 60Hz. Install in accordance with the pump manufacturer's instructions using standard plumbing practices. Size the circulator pump taking into account the pressure loss through the tankless coil boiler or instantaneous water heater as well as pressure losses through the connecting pipes that are part of the circulating loop.

## SIZING THE HOT WATER SYSTEM

Temperature of the system is controlled by the temperature set point of the instantaneous water heater or boiler coil. Given the limited storage capacity of the storage tank and the maximum output of the tankless coil boiler or instantaneous water heater, large hot water draws significantly exceeding the circulating loop flow rate may lead to a reduction in temperature of hot water delivered.

## PLUMBING CONNECTIONS

### **⚠ WARNING**

#### **Toxic Chemical Hazard**

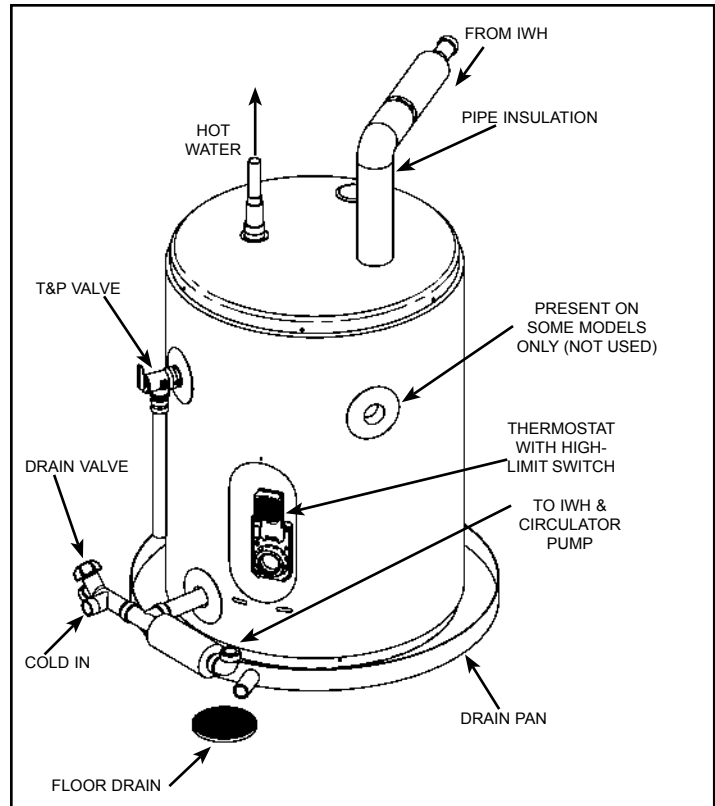
The water heating source piping and components connected to the tank must be suitable for potable water use. TOXIC chemicals such as used for boiler treatment must not be introduced into the tank.

For a temperature controlled instantaneous water heater it is recommended to install the plumbing as shown in Figure 2. It is also recommended to set-up and control the IWH outlet temperature to be at least 11°C (20°F) above tank thermostat temperature. The recommended plumbing installation for a tankless coil boiler is shown in Figure 3. In this case, because the tankless coil boiler is able to control only the differential between inlet and outlet temperature, the cold water entering the tankless coil boiler must be tempered with hot water from the storage tank. As there is a large variety of heat sources and control systems, please contact your local distributor for the plumbing system to identify the solution that best suits your application.

### **CAUTION**

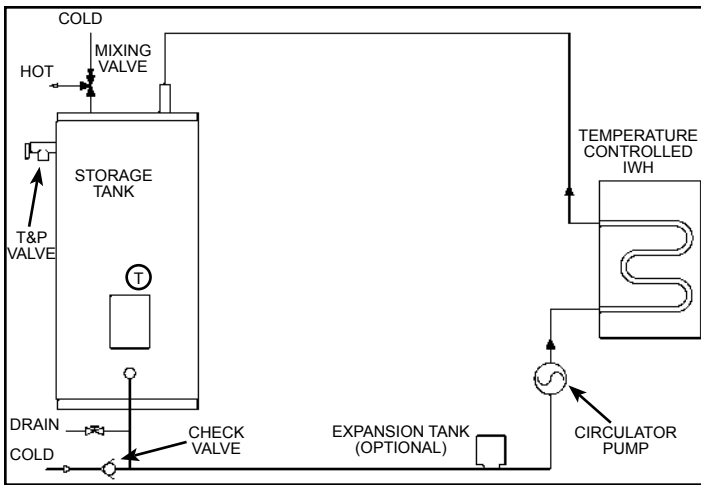
#### **Property Damage Hazard**

Do not apply heat directly to tank fittings when making sweat connections. They contain non-metallic material.

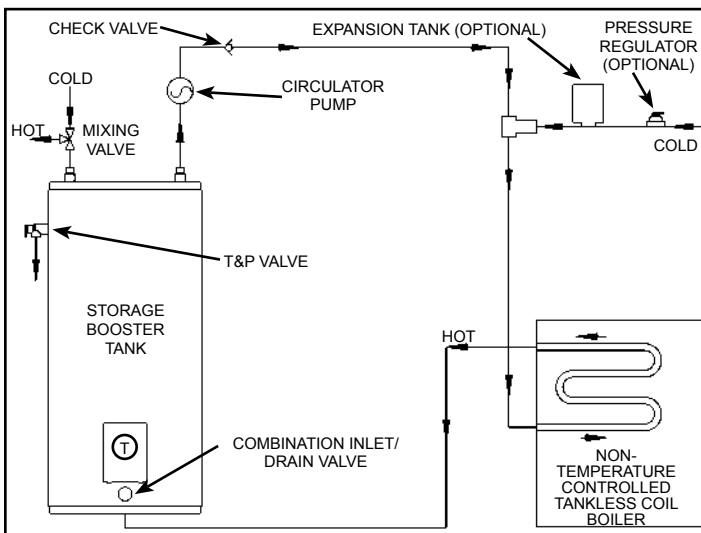


**Figure 1. Main Parts and Features for Connection to a Temperature Controlled IWH**

1. Ensure the storage tank is level before starting installation.
2. Install a circulation loop as shown using 19mm (3/4 in.) copper piping.
3. If the heating source is a tankless coil boiler go to Step 4. If a temperature controlled IWH is used as a heat source, install the combination inlet/drain valve in one "arm" of a tee connected to the lower storage tank fitting. Connect the cold water supply piping to the inlet of the combination inlet/drain valve. Connect the other "arm" of this tee to the IWH inlet line and place the circulating pump in this line. Connect the IWH outlet to the upper storage tank side fitting (see Figure 2). Proceed to Step 5.
4. For a tankless coil boiler install the combination inlet/drain valve in the lower storage tank fitting. Connect the inlet of a combination inlet/drain valve to the hot outlet of the tankless coil boiler. In this instance the "leg" of a tee should connect to the cold water supply line, one "arm" connects to the circulator pump and the other "arm" to the inlet of the tankless coil boiler. The circulator pump connects to the upper side fitting of storage tank (see Figure 3).



**Figure 2. Single Storage Tank Plumbing for a Temperature Controlled IWH**



**Figure 3. Single Storage Tank Plumbing for a Non-Temperature Controlled Tankless Coil Boiler**

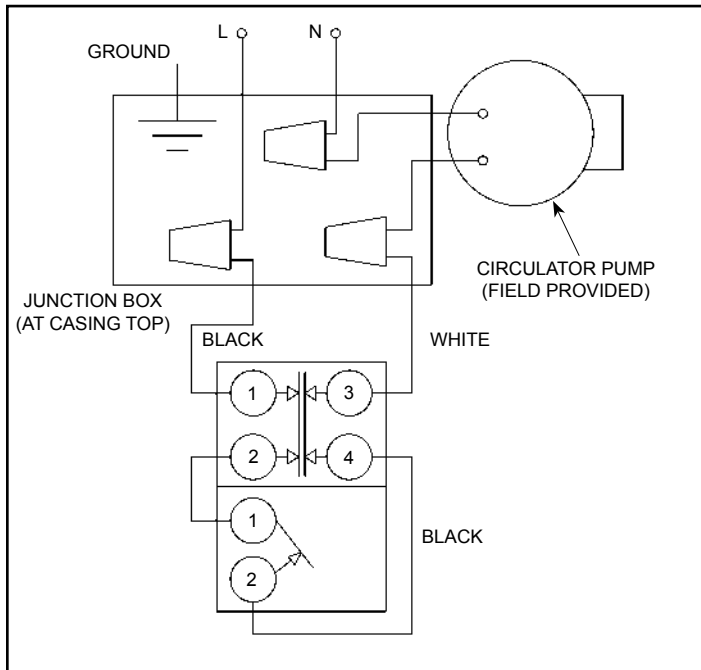
5. Pay attention to the desired flow direction when installing the circulator pump. If the pump does not have a check valve embedded install one to ensure the desired flow direction is maintained during system operation.
6. Install a mixing valve with the hot port going to the top tank fitting. Connect the domestic hot water supply line to the mixing port of the mixing valve. Connect the cold port of the mixing valve to the cold water supply line and place a shut-off in this line. Most mixing valves do not operate properly if the pressure differential between hot and cold port is too high. If this happens, lower mixed water temperature will be provided. The shut-off valve should be used to adjust this pressure differential. Set the mixing valve outlet temperature to 49°C (120°F) to avoid scalding.
7. A check valve may be installed in the cold water line before the connecting tee.  
**Note:** The check valve can often be noisy and cause reduced supply pressures. For multiple storage tank systems, check valves must be installed to prevent the circulator pump from pumping hot water into another tank and overheating it.

8. The use of a pressure regulator is optional, but recommended when the cold supply pressure is over 80 psi. Reducing the inlet pressure to 45-60 psi will reduce probability of relief valve discharge due to thermal expansion.
9. The water utility supply meter may contain a check valve, back-flow preventer or water pressure-reducing valve. This will create a closed water system. During a heating cycle, water expands creating a pressure buildup in the water system. A Temperature and Pressure (T&P) Relief Valve must be installed (150 psi maximum pressure). See preceding section. If the T&P valve discharges periodically, it may be due to thermal expansion in a closed system. To prevent this condition and to reduce the possible buildup of lime on the T&P Relief Valve seat, install a thermal expansion tank in the circulating loop as shown in Figure 2 and Figure 3.
10. Some jurisdictions require a Vacuum Relief Valve to be installed. Such a valve allows air to enter the piping system thus preventing vacuum conditions that could siphon water from the system. Check local code requirements.

## ELECTRICAL WIRING

Electrical wiring must be in accordance with local codes or, in the absence of such codes, with the “**Canadian Electrical Code**”, (C22.1) Part I or the “**National Electrical Code**”, (NFPA 70) as applicable.

1. Supply 110/120 volts, 60Hz power, to the junction box located at the top of the tank.
2. Connect the circulator pump in series with the thermostat as shown in Figure 4.
3. A ground wire must be supplied from the ground connection at the service panel to the ground screw at the junction box.



**Figure 4. Wiring Diagram**

4. The thermostat is rated for a maximum inductive current of 7 FLA at 120 VAC. Do not exceed this rating for the circuit.
5. Do not install or connect electrical heating elements to this tank.

## FILLING

**NOTE:** When filling, avoid water leakage. Do not allow the insulation of the tank to get wet as water can cause electrical malfunction or reduce the effectiveness of the insulation.

1. To insure complete filling of the tank, allow air to exit by opening a hot water faucet that is served by the tank and is some distance away from the heater.
2. Ensure the storage tank drain valve is closed.
3. Open the cold water supply valve and fill the tank and piping system with water. When an uninterrupted stream of water, without apparent air bubbles, flows from the open hot water faucet, the system is full.
4. Close the open hot water faucet. Check the system for leaks, repair as necessary and retest.
5. Connect a hose to the drain valve and route to a suitable drain. Open the drain valve and let water run to flush out any foreign matter that may have entered the system. Once flushed, close the drain valve and disconnect hose.

## OPERATION

1. Follow boiler or instantaneous water heater installation and operating instructions.
2. Fill the tank (see "Filling" section).
3. The boiler or instantaneous water heater should be set to provide at least 11°C (20°F) higher water temperature than the temperature setting of the storage tank.
4. Turn power on, check for proper operation of boiler or instantaneous water heater and storage tank.

## TEMPERATURE ADJUSTMENT

**⚠ DANGER** Water temperature over 52°C (125°F) can cause severe burns instantly resulting in severe injury or death.

Children, the elderly and the disabled and are at highest risk of scald injury.

Feel water before bathing or showering.

Temperature limiting valves are available.

Read instruction manual for safe temperature setting.

Thermostats are factory set at 60°C (140°F). The thermostat operates automatically. It can be adjusted to provide a higher or lower water temperature.

If water temperature adjustment is required:

1. Turn the electrical supply "OFF".
2. Remove the access door and insulation pad.
3. Check with a voltage tester at terminal 1 and 3 of the limit control that power is indeed "OFF".
4. Adjust the thermostat to the water temperature desired.
5. Ensure insulation pad is in the door cavity. Replace access door(s).
6. Turn the electrical supply "ON".

## ⚠ WARNING

### Risk of scalding

**There is a hot water scald potential if the thermostat is set too high.**

**Adjusting the thermostat past the 49°C (120°F) bar on the temperature dial will increase the risk of scald injury. Hot water can cause severe burns in:**

1 1/2 seconds at	66°C (150°F)
3 seconds at	60°C (140°F)
20 seconds at	54°C (130°F)

## INITIAL TEMPERATURE ADJUSTMENT

1. For the temperature controlled IWH, ensure the temperature set point is 11°C (20°F) higher than the storage tank set point.
2. If at the end of the recovery cycle, the IWH is OFF but the circulator pump does not turn OFF automatically, reduce the storage tank thermostat set point until the pump shuts off. Check that pump is off.

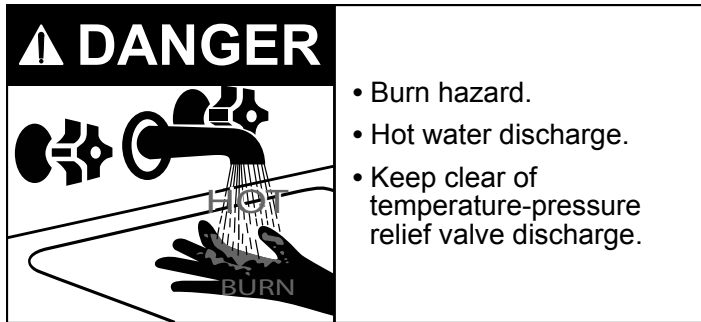
## TEMPERATURE LIMIT CONTROL

For safety, a non-adjustable high limit temperature switch will shut off the power when excessive water temperatures are reached. This switch must be re-set manually.

## MAINTENANCE

### TEMPERATURE AND PRESSURE RELIEF VALVE

Manually operate the temperature and pressure relief valve at least once a year to make sure it is working properly. To prevent water damage, the valve must be properly connected to a discharge line that terminates at an adequate drain.



**Standing clear of the outlet (discharged water may be hot),** slowly lift and release the lever handle on the temperature and pressure relief valve (see Figure 5) to allow the valve to operate freely and return to its closed position. If the valve fails to completely reset and continues to release water, immediately turn "OFF" the electrical supply to the tank, close the cold water supply valve and call a qualified service technician.

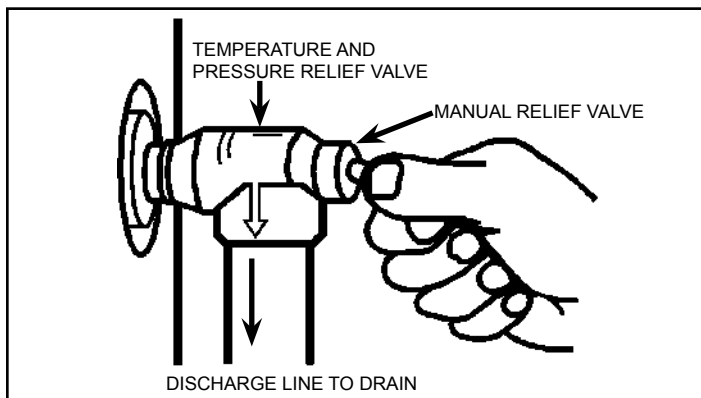
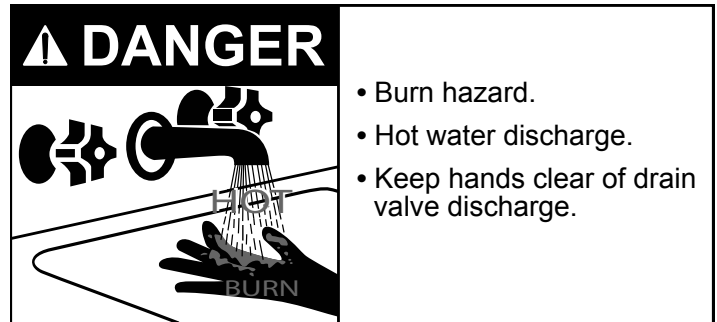


Figure 5. T&P Relief Valve Test

## DRAINING AND FLUSHING

It is recommended that the storage tank be drained and flushed every 6 months to remove sediment that may build up during operation. The storage tank should also be drained if being shut down for extended periods of time. To drain the tank, perform the following steps:

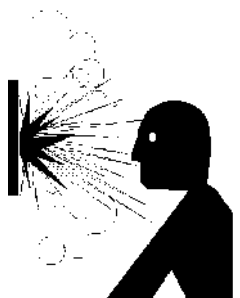


1. Turn "OFF" the electrical supply to the tank.
2. Close the cold water supply valve.
3. Open a nearby hot water faucet served by the system.
4. Connect a hose to the drain valve and route it to an adequate drain.
5. Open the drain valve and allow all the water to drain from the tank.
6. Open the cold water supply valve and flush the tank as needed to remove sediment and any other foreign matter that may have entered the system. Close the cold water supply valve when clean water flows.
7. Perform any other servicing as required.
8. Close the drain valve, disconnect hose and refill the tank (see "Filling" section). If the water heater is going to be shut down for an extended period, the drain valve should be left open.
9. Turn "ON" the electrical supply to the tank.

## WATER ODOR/SACRIFICIAL ANODE

Your storage tank has been equipped with one magnesium anode that will slowly deplete while protecting the glass-lined tank thus prolonging its life. Certain water conditions may cause a reaction between the anode and the water. The most common complaint associated with the anode is a "rotten egg smell" produced by the presence of sulfur. Do not remove this anode permanently as it will void any warranties, stated or implied. An aluminum anode may reduce if not eliminate water odor problems. The water supply system may require special filtration equipment from a water conditioning company to successfully eliminate all water odor problems. Artificially softened water is exceedingly corrosive because the process substitutes sodium ions for magnesium and calcium ions. The use of a water softener may decrease the life of the water heater tank. The anode should be inspected periodically. If the anode is more than 50% depleted, the anode should be replaced.

## ANODE MAINTENANCE

	<b>WARNING</b>
	<b>Explosion Hazard</b> <ul style="list-style-type: none"><li>• Flammable hydrogen gases may be present.</li><li>• Keep all ignition sources away from faucet when turning on hot water.</li></ul>

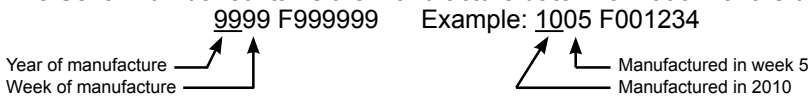
**HYDROGEN GAS:** Hydrogen gas can be produced in a hot water system that has not been used for a long period of time (generally two weeks or more). Hydrogen gas is extremely flammable and explosive. To prevent the possibility of injury under these conditions, we recommend the hot water faucet, located farthest away, be opened for several minutes before any electrical appliances which are connected to the hot water system are used (such as a dishwasher or washing machine). If hydrogen gas is present, there will probably be an unusual sound similar to air escaping through the pipe as the hot water faucet is opened. There must be no smoking or open flame near the faucet at the time it is open.

1. Turn "OFF" the electrical supply to the tank.
2. Close the cold water supply valve.
3. Open a nearby hot water faucet served by the system to depressurize the system.
4. Connect a hose to the drain valve and drain 22 litres (6 gal.) as directed in the "Draining and Flushing" section.
5. Using an adjustable pipe wrench, remove the anode and inspect it. The surface may be rough, full of pits and crevices, but this is normal. If it is less than approximately 6mm (1/4 in.) in diameter, or the inner steel core is exposed, the anode should be replaced.
6. Apply Teflon™ tape or sealing compounds approved for use with potable water, to the threads of the anode and install into the tank top.
7. Open the cold water supply valve and open a nearby hot water faucet to purge air from the tank as directed in the "Filling" section.
8. Check for leaks, repair as required, and re-test.
9. Turn "ON" the electrical supply to the tank.



When referencing the water heater for service or warranty, please refer to the rating plate affixed to the unit.

The Serial Number contains the manufacture date information for the unit as follows:



The warranty period for the unit is as follows:

Model	GST
Inner Tank Warranty Years	8
Component Part Warranty Years	6

## LIMITED WARRANTY

### RESIDENTIAL STORAGE TANK TYPE WATER HEATER FOR INSTALLATION IN A SINGLE FAMILY DWELLING

#### A. WHO IS COVERED.

GSW WATER HEATING AND ITS SUPPLIERS, (herein collectively referred to as “Manufacturer”) warrants only to the original consumer purchaser (hereinafter “Owner”) of the water heater, within the boundaries of the continental United States or Canada, or their territories, so long as he or she continuously occupies the single family dwelling in which this water heater is initially installed for the period specified below. This Warranty is not transferable. This Warranty is reduced to one year if the water heater is used in a commercial or industrial application, or if the water heater is used to supply more than one dwelling unit. Consumers must retain point-of-sale proof of purchase to validate warranty entitlement.

#### B. WHEN IT IS COVERED.

The water heater is warranted only when it is installed, operated, and maintained in accordance with the printed instructions accompanying the water heater. The water heater shall/must be installed in such a manner that, if the tank or any connection thereto should leak, the resulting flow of water will not cause damage to the area in which it is installed. The water heater's temperature and pressure relief valve must be piped to the nearest drain to avoid damage in the event the valve is actuated. For detailed instructions, read the manual accompanying the water heater and review drawings in the manual.

#### C. WHAT THE MANUFACTURER WILL DO AND THE PERIOD OF COVERAGE.

- 1. The Inner Tank.** If the inner tank leaks within the warranty period shown in the table above after the original installation, the Manufacturer will furnish a new water heater of the Manufacturer's then prevailing comparable model. If industry standards, regulatory changes, product improvements, or product obsolescence prohibits the Manufacturer from furnishing an identical model replacement water heater under this Warranty, the Owner will be furnished with a new water heater of comparable capacity; however, the Owner will be charged for the additional value of the item(s) which the Manufacturer has incorporated in the replacement water heater. A prior authorization number must be obtained from the Manufacturer before replacing the water heater. This Warranty is limited to one replacement water heater at the original installation site.
- 2. Component Part.** If any component, part other than the inner tank, proves to the Manufacturer's satisfaction to be defective in material or workmanship within the warranty period shown in the table above after the original installation, the Manufacturer will furnish the Owner with a replacement for the defective part(s). This Warranty is limited to one replacement component part for each original part.
- 3. Return of Defective Water Heater and Component Parts.** The Manufacturer reserves the right to examine the alleged defect in the water heater or component part(s). As such, it will be the Owner's obligation (see paragraph D. 3) to return the water heater and/or component part(s) to the Manufacturer.
  - a. When returning a water heater, it must include all component parts and the rating plate label.
  - b. When returning component part(s), they must be individually tagged and identified with the water heater's Model Number, SKU, Serial Number, date of purchase, and date of installation.
  - c. THERE ARE NO WARRANTIES WHICH EXTEND BEYOND THE DESCRIPTION ON THE FACE HEREOF. THIS EXPRESS WARRANTY IS, WHERE PERMITTED BY LAW, IN LIEU OF AND EXCLUDES AND REPLACES ALL OTHER CONDITIONS, WARRANTIES, GUARANTEES, REPRESENTATIONS, OBLIGATIONS OR LIABILITIES OF THE MANUFACTURER OF ANY NATURE OR KIND, EXPRESS OR IMPLIED, HOWEVER ARISING (WHETHER BY CONTRACT, CONDUCT, STATEMENT, STATUTE, NEGLIGENCE, PRINCIPLES OF MANUFACTURER'S LIABILITY, OPERATION OF LAW, OR OTHERWISE) WITH RESPECT TO THE UNIT OR ITS FITNESS FOR A PARTICULAR PURPOSE, MERCHANTABILITY, INSTALLATION, OPERATION, REPAIR, OR REPLACEMENT. THE MANUFACTURER EXPRESSLY DISCLAIMS ANY AND ALL IMPLIED WARRANTIES. IN NO EVENT WILL THE MANUFACTURER'S LIABILITIES EXCEED THE COST OF THE DEFECTIVE PART(S) OR UNIT.

#### D. WHAT THIS WARRANTY DOES NOT COVER.

1. The Unit must not be installed where water damage can result from a leak, while provision(s) shall be made for directing any water escaping from the Unit to a properly operating drainpipe. As all units of this type may eventually leak, you must protect against any potential water damage. The Manufacturer accepts no responsibility for such damage, nor any incidental or consequential loss, nor damage(s) related thereto, suffered by the Owner of the Unit nor by any third party.
2. The Manufacturer shall not be liable under this Warranty and this Warranty shall be void and have no effect if the following events occur:
  - a. The water heater or any of its component parts have been subject to misuse, alteration, neglect, or accident; or

- b. The water heater has not been installed in accordance with the applicable local plumbing and/or building code(s) and/or regulations or, in their absence, with the latest edition of the Natural Gas and Propane Installation Code, and/or the Canadian Electrical Code; or
  - c. The water heater is not installed, operated, and maintained in accordance with the Manufacturer's instructions, including if the water heater has any additional aftermarket equipment introduced into the sealed system not approved by the Manufacturer; or
  - d. The water heater or any of its component parts are damaged or fails from operation with an empty or partially empty tank (such as, but not limited to elements burned out in a dry tank); or
  - e. The water heater or any part has been under water; or
  - f. The water heater is exposed to highly corrosive atmospheric conditions. No warranty extends, for example, and without limitation of the foregoing, to Units exposed to: salts, chemicals, exhausts, pollutants, or contaminants; or
  - g. The water heater is not continuously supplied with potable water; or
  - h. The water heater replacement is requested for reasons of noise, taste, odour, discolouration, and/or rust; or
  - i. The water heater is operated at temperatures exceeding the maximum setting of the thermostat and/or high limit control provided by the Manufacturer, or at water pressures exceeding the pressure reading stated on the Unit; or
  - j. The water heater is operated without an operating anode; or
  - k. The water heater is supplied or operated with deionized water; or
  - l. The water heater is removed from its original installation location; or
  - m. The water heater is installed outdoors (this water heater is intended only for indoor installation); or
  - n. The water heater is converted, or is attempted to be converted, from one voltage or wattage to another, if an electric water heater, or from one gas type to another, if a gas water heater; or
  - o. The water heater has not been fired at the factory rated input and fuel for which it was factory built; or
  - p. The water heater or any of its component parts fail due to sediment build-up; or
  - q. The water heater does not have installed a properly operating temperature and pressure relief valve, certified to ANSI Z21.22/CSA "Requirements for Relief Valves for Hot Water Supply Systems"; or
  - r. The water heater or any of its component parts fail because of fire, floods, lightning, or any other act of God, or any other contingency beyond the control of the Manufacturer; or
  - s. The water heater is installed in a closed system without adequate provision for thermal expansion.
3. Except when specifically prohibited by the applicable law, the Owner, and not the Manufacturer, shall be liable for and shall pay for all charges for labour or other expenses incurred in the removal, repair, or replacement of the water heater or any component part(s) claimed to be defective or any expense incurred to remedy any defect in the product. Such charges may include, but are not necessarily limited to:
- a. All freight, shipping, handling, and delivery costs of forwarding a new water heater or replacement part(s) to the Owner.
  - b. All costs necessary or incidental in removing the defective water heater or component part(s) and installing a new water heater or component part(s).
  - c. Any material required to complete and/or permits required for the installation of a new water heater or replacement part(s), and
  - d. All costs necessary or incidental in returning the defective water heater or component part(s) to a location designated by the Manufacturer.
4. The terms of this Limited Warranty cannot be modified by any person, whether or not he/she claims to represent or act on behalf of the Manufacturer.
- E. HOW THE ORIGINAL OWNER CAN MAKE A WARRANTY CLAIM.
- 1. The Owner should submit the warranty claim direct to the Manufacturer's Service Department, at the address or phone number listed below, and the Manufacturer will arrange for the handling of the claim.
  - 2. Whenever any inquiry or request is made, be sure to include the water heater's Catalogue Number, Model Number, Serial Number, date of purchase, date of installation, and location of installation.

This Warranty and the Manufacturer's obligations shall be construed and determined in accordance with the laws of both the Province of Ontario, and of Canada in force therein. This Warranty does not affect specific legal rights of a consumer under applicable law, except to the extent that such rights may be waived or replaced, and the provisions hereof are deemed to be amended to the extent necessary. The unenforceability of any provision, in whole or in part, of this Certificate shall not affect the remaining provisions. Any and all repair and/or replacement of part(s) or Unit are the sole and exclusive remedy available against the Manufacturer.

John Wood Water Heaters  
 599 Hill Street West  
 Fergus, ON Canada N1M 2X1  
 Should you have any questions, please  
 Visit us online at [www.johnwoodwaterheaters.com](http://www.johnwoodwaterheaters.com), or  
 E-mail us at [techsupport@gsw-wh.com](mailto:techsupport@gsw-wh.com), or  
 Call our Technical Support line at 1 888 GSW TECH (479 8324)